Product Specifications

NAME: Touch Panel Color-temperature Controller



Summarization

Touch panel controller is a new high-end controller which newly developed by our company. It adopts glass panel design, is beautiful and fashionable in appearance. It adopts high precision capacitance touch control chip, increases the touch sensitivity, reduces trigger which caused by mistake. It is used for controlling a variety of lamp whose source of light is LED. For instance, point source of light,flexible light strip, wall washer lamp, glass curtain wall light etc., it has many advantages such as convenient to connect, easy to use and others. It can carry out cold, warm, white light and other effects of lighting change.

Technical Parameters

- working temperature: -20-60 °C
- supply voltage: DC12-24
- output: 2 channels
- connection mode: common anode
- external dimension: L86 X W86X H36mm
- packing size: L110 X W110 X H55 mm
- net weight: 125g
- gross weight: 185g
- static power consumption: <1W
- output current: <4A(each channel)
- output power: 12V<96W,24V<192W

External Dimension

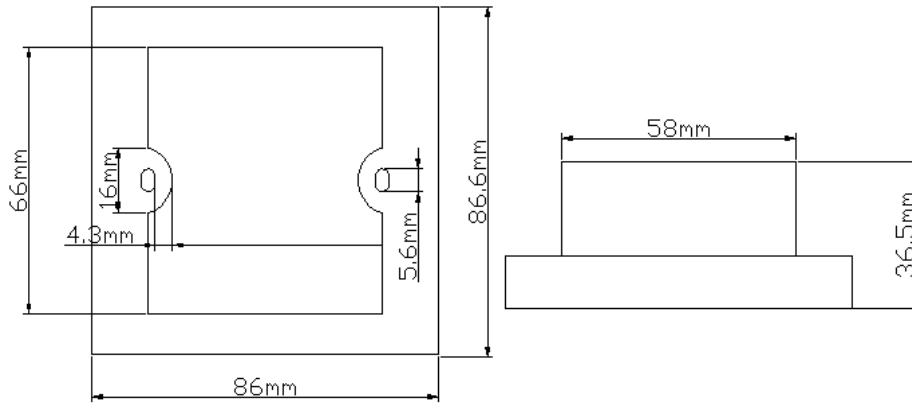

Interface Specifications

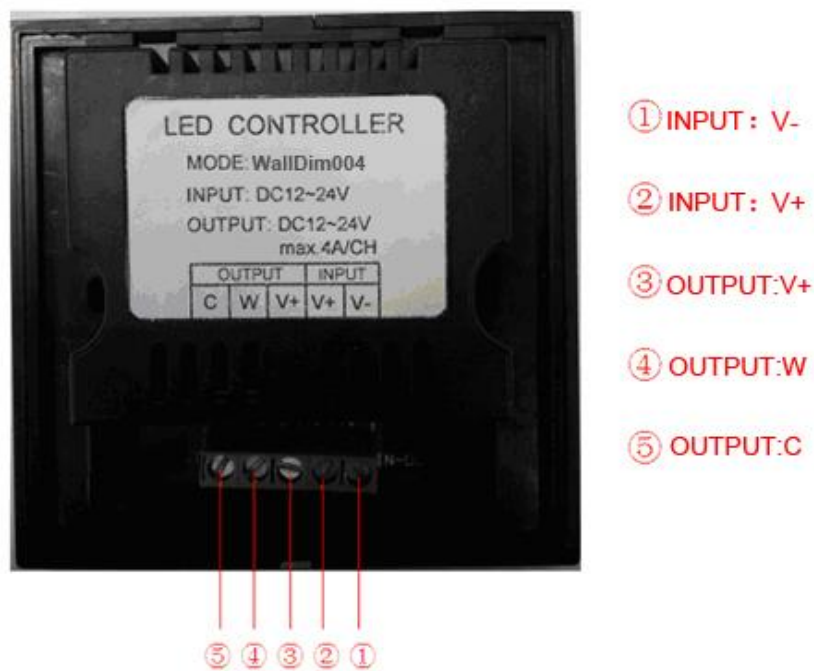

Controller instruction:

1. Touch panel has two buttons and a pulley key, the functions are as follows:

 you could turn on/off controller at any state;

M: the color change button, there are 11 kinds of change patterns for you to choose, press the key for long time, you can turn on/ off the buzzer

Multicolor pulley touch key, color mode selection key, up to 64 touch points.

The button has two functions:



- 1) Pulley color selection key, so when the current control mode is M key mode (color), if must realize pulley static color, you can press this key.
- 2) Pulley color switch key, can change from 64 kinds of colors (as the pulley shown)

2. standard change is shown in the below table:

Mode No.	Function	Remark
1	Cold White	
2	Cold White +20% warm white	
3	Cold White +40% warm white	
4	Cold White +60% warm white	
5	Cold White +80% warm white	
6	White	
7	warm white +80% Cold White	
8	warm white +60% Cold White	
9	warm white +40% Cold White	
10	warm white +20% Cold White	
11	warm white	

Typical Application

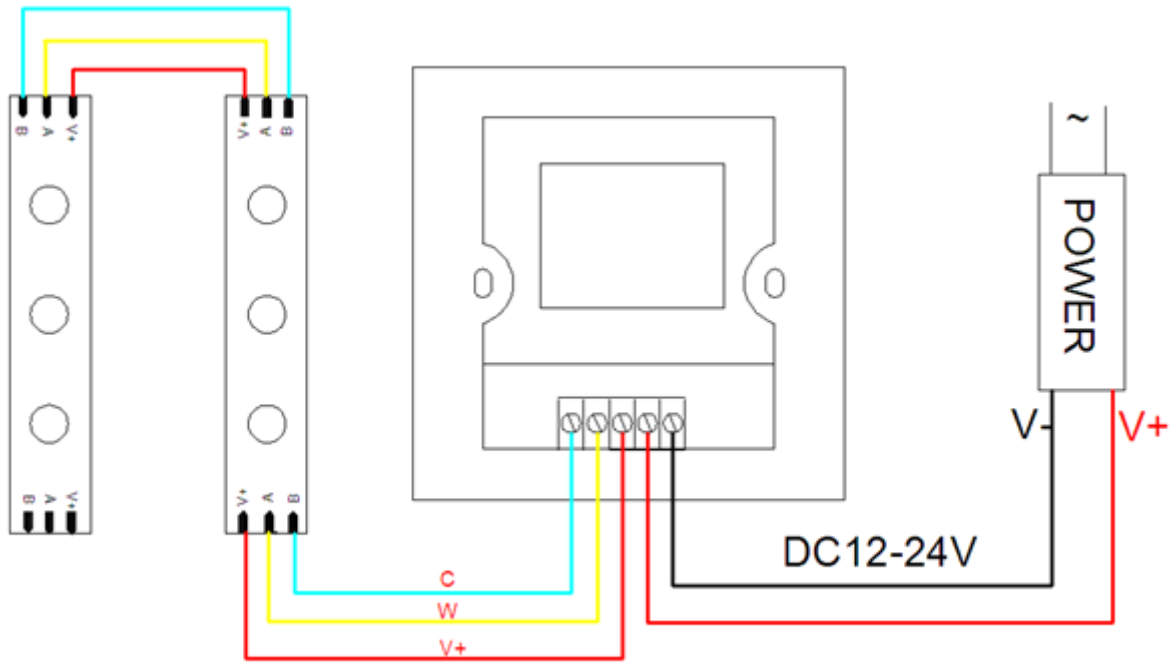

Installation Method

(1) gently pry gaps in touch panel with a screwdriver, and then you can slowly remove the panel, as shown below;





(2) remove the cable. Pull the locking of the terminal transposon, and then you can slowly remove the cable, as shown below:

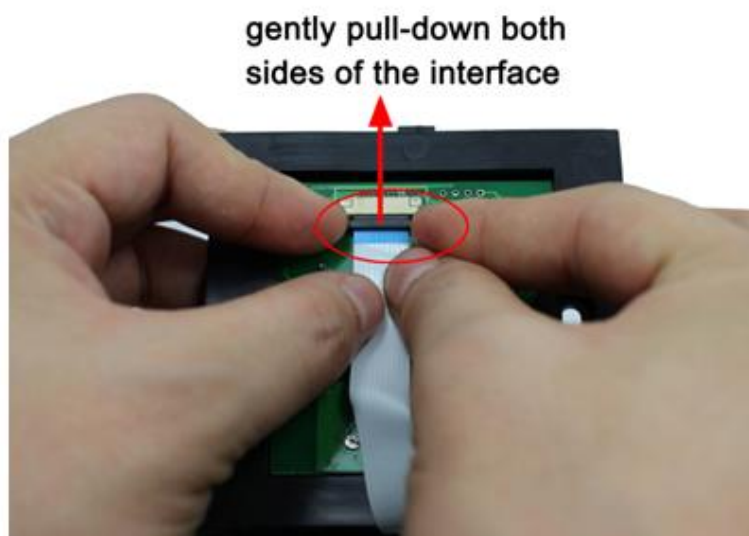
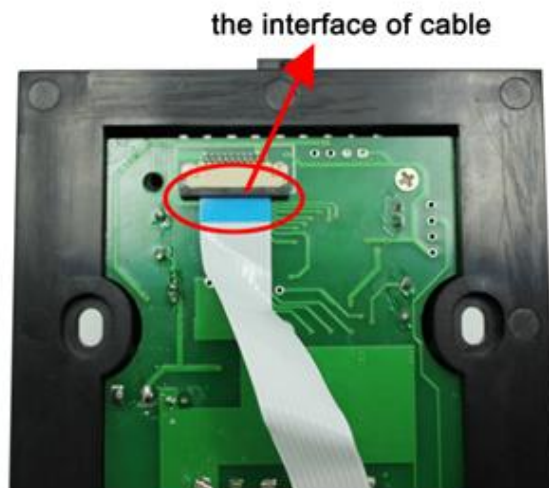

unplug the cable



3. Fix the base of controller in the 86×86 installation box (customers need to buy the installation box by themselves) on the wall with screws.

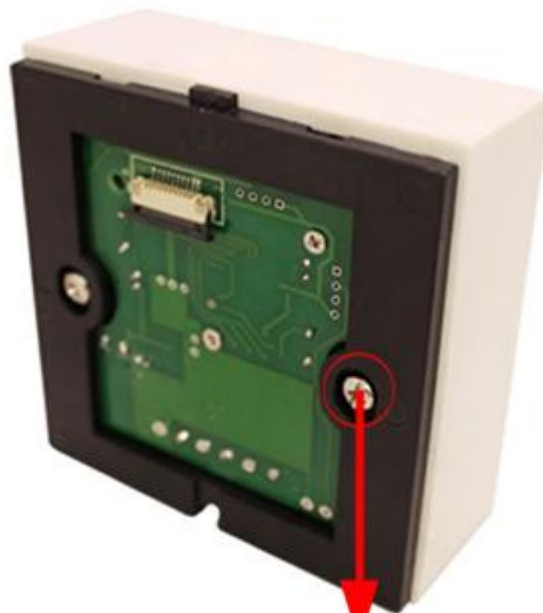

fix the controller
on the base

(4) use your hand gently pull down the cable seat lock according to step 2, plug the cable into cable seat, press the lock, and mount the cable of panel on the base, as shown below:

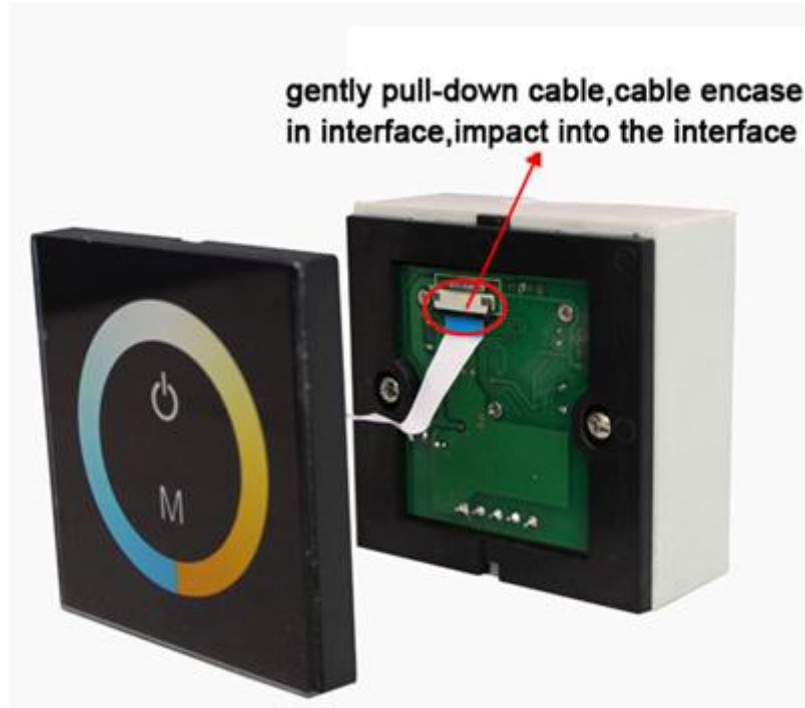

(5) installation is completed, as shown below:



Remarks:

1. Connect the load wire at first, following by the power wire; **Please ensure short circuit can not occur between connecting wire before you turn on the power;**
2. The supply voltage of controller ranges in DC12V~DC24V, it may burn out the controller once exceed the voltage ranges.