

LIGHT ENGINE INSTRUCTION MENU

LEP-1002
LEP-1002DMX

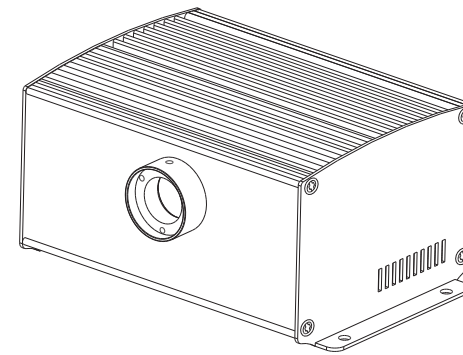

Accessories:

- Fiber Connector1 PCS
- Wireless Remote Controller.....1 PCS(Optional)
- Instruction Menu1 PCS
- Certification1 PCS



**ISO9001:2000
CERTIFIED**

LEP-1002

A. Safety Instruction

1. Make sure the Light Engine and Power Source have the same voltage;
2. Keep out of rain or moist area to avoid shock hazards;
3. Avoid to use at high temperature ($\leq 40^{\circ}\text{C}$);
4. Keep ventilation.

B. Technical Data

Voltage: 12V DC
 Power: 25W
 Color: 6colors
 LED: 2-10W LED
 LED Life: 50000H
 Quantity of Fiber: 0.75mm \times 250pcs Single-head (Standard aperture ϕ 14mm)
 0.75mm \times 400pcs Single-head (Max ϕ 17.3mm)

C. Installation

The installation dimension of Light Engine and rear panel (Fig. 1)

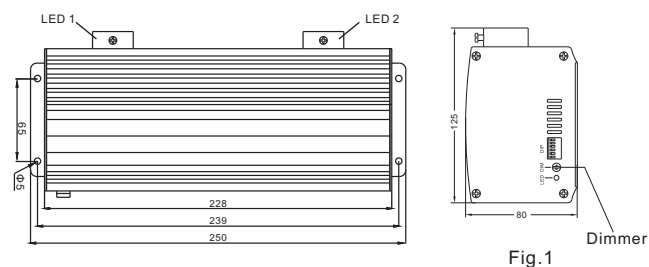

D. Installation of the fiber optic (Fig.2)

1. Cut fibers into specified length, if it is multi-string fiber, then you need to peel off 5-10cm PVC sleeve carefully to avoid hurting the inner fiber;
2. Collect all fibers in one bundle, enlase all of fibers at the 10cm location of one end with tape, Insert fibers into the waterproof connector and fiber connector, screw the waterproof connector tightly; Cut the fibers with hot knife;
3. Rotate the whole finished fiber connector into the fiber fixing ring, screw tightly the screw.
4. The installation of the end part of the fiber optic

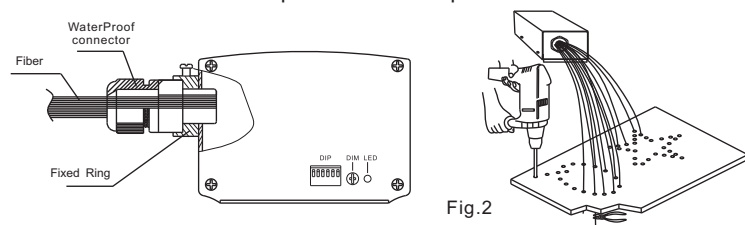

E. Setting of Light Engine:

1. DIP switch setting: DIP1-3 as program switch, please see setting as follow (1=ON, 0=OFF), DIP 4-5 is blank, DIP 6 is for remote controller (Fig. 3)
2. Calculation of DIP address code:
 e. g. 009=8(4)+1(1), 013=8(4)+4(3)+1(1)
3. Using of Wireless Remote Controller:
 Firstly set DIP No.6 into "ON", select color with button "☰", button "☷" used for power on/off, button "▲" "▼" used for brightness adjusting (6 levels) (Fig. 4)
4. Fixing Color Without Wireless Remote controller : Firstly set DIP No. 2 and No. 3 into "ON" to select the program with slowest speed, then set all of DIP into "OFF" when it display the color that you need.

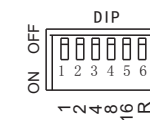

Fig. 3

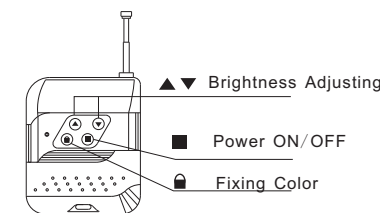

Fig. 4

RC-04
Wireless Remote Controller

Notice:

1. You can only control running/stopping of the motor through "☷" button, if you want to select the color change speed, please use DIP switch.
2. The dimmer on the rear panel is used for brightness adjusting by hand, factory default is 100% brightness, total 6 levels brightness.

Attached List:

PRO. NO.	DIP SWITCH(1=ON, 0=OFF)						FUNCTION
	6	5	4	3	2	1	
00	0	0	0	0	0	0	Motor stopped, LED working
01	1	0	0	0	0	1	W, G, Sky-B, Y, B, PP, fade (6RPM)
02	1	0	0	0	1	0	W, G, Sky-B, Y, B, PP, fade (4RPM)
03	1	0	0	0	1	1	W, G, Sky-B, Y, B, PP, fade (3RPM)
04	1	0	0	1	0	0	W, G, Sky-B, Y, B, PP, fade (2RPM)
05	1	0	0	1	0	1	W, G, Sky-B, Y, B, PP, fade (1.5RPM)
06	1	0	0	1	1	0	W, G, Sky-B, Y, B, PP, fade (1RPM)
07	1	0	0	1	1	1	W, G, Sky-B, Y, B, PP, fade (0.5RPM)

- Notice: 1. RPM is the speed of the color wheel;
 2. When DIP address exceed P07, system will run P07 all the time;

LEP-1002 DMX

A. Safety Instruction

1. Make sure the Light Engine and Power Source have the same voltage;
2. Keep out of rain or moist area to avoid shock hazards;
3. Avoid to use at high temperature ($\leq 40^{\circ}\text{C}$);
4. Keep ventilation.

B. Technical Data

Voltage: 12V DC

Power: 25W

Color: 6colors

LED: 2-10W LED

LED Life: 50000H

Quantity of Fiber: 0.75mm \times 250pcs Single-head (Standard aperture \varnothing 14mm)
0.75mm \times 400pcs Single-head (Max \varnothing 17.3mm)

C. Installation

The installation dimension of Light Engine and rear panel (Fig. 1)

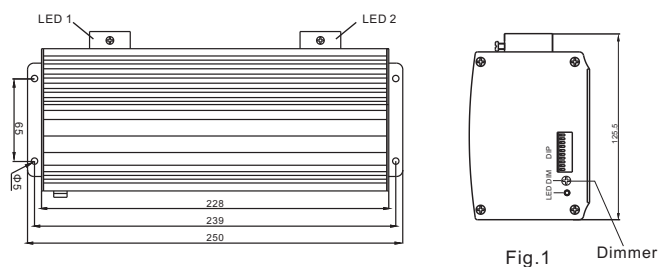

Fig.1 Dimmer

D. Installation of the fiber optic (Fig.2)

1. Cut fibers into specified length, if it is multi-string fiber, then you need to peel off 5-10cm PVC sleeve carefully to avoid hurting the inner fiber;
2. Collect all fibers in one bundle, enlase all of fibers at the 10cm location of one end with tape, Insert fibers into the waterproof connector and fiber connector, screw the waterproof connector tightly; Cut the fibers with hot knife;
3. Rotate the whole finished fiber connector into the fiber fixing ring, screw tightly the screw.
4. The installation of the end part of the fiber optic

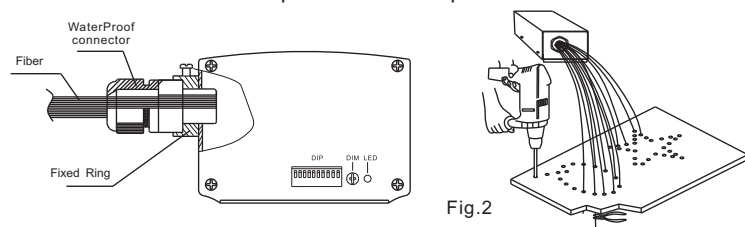
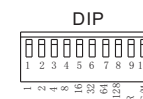

Fig.2

E. Setting of Light Engine

Light Engine Master/Slave has two control modes:

- * DMX512 Signal mode: The Working of LED light engine is controlled by DMX512 Program controller.
 - * Master/Slave mode: One LED light engine as Master, all the others as slave.
1. DIP address setting: DIP1-8 as DIP address, please see setting as follow (1=ON, 0=OFF), DIP9 as remote controller (1=ON, 0=OFF), DIP10 as Master, when DIP10=1, DIP1-5 as program choose DIP6~8 is blank; when DIP10=0, DIP1-8 as DIP address .



DMX add	10	9	8	7	6	5	4	3	2	1
001	1	0	0	0	0	0	0	0	0	1
002	1	0	0	0	0	0	0	0	1	0
003	1	0	0	0	0	0	0	0	1	1
004	1	0	0	0	0	0	0	1	0	0
005	1	0	0	0	0	0	0	1	0	1
---	---	---	---	---	---	---	---	---	---	---
011	1	0	0	0	0	1	0	1	1	1
---	---	---	---	---	---	---	---	---	---	---
022	1	0	0	0	0	1	0	1	1	0

2. Calculation of DMX Address:

i.e. DMX Address 018 = 16(5) + 2(2), 022 = 16(5) + 4(3) + 2(2)

3. Dimming potentiometer: the brightness is max. when delivery, you can adjust the brightness by hand.
4. DMX Channels:
CH1: Color CH2: Speed of color wheel CH3: Blank CH4: Dimmer + Strobe
5. The connection of DMX Signal Control Mode:

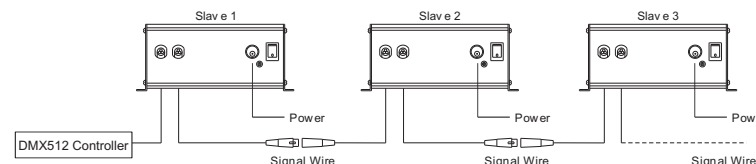

6. The connection of Master/Slave Control Mode:

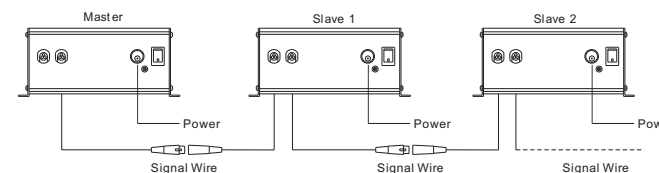

7. Signal wire and the connector link:

Signal wire should be 2 \times 0.5mm² audio wire.



8. Wireless remote controller using:

Set DIP9 & DIP10 to ON, others is OFF. then you can use remote controller.

(1) "PRO" is used for selecting Programs:

Press "PRO" then press button ①-⑥ to do addition .max. is 30
e.g. if you want to select the 9th program, then you can
press "4" and "5" (or you can also press "3" and "6");

(2) "DIM" is used for dim the brightness:

Press "DIM", default brightness is 100%, use "↑"/"↓" or relative
number button to adjust;

①-10%, ②-20%, ③-40%, ④-60%, ⑤-80%, ⑥-100%

(3) ↑/↓ UP/DOWN button:

After you press "PRO" and "DIM", you can change the
parameters by "↑"/"↓"; When pressing UP/DOWN button,
if it is within the range of effective number, then light engine
will work accordingly;

(4) "⏻" ON/OFF button:

Light engines will run the last program before you power off it;

(5) "ENT" enter button: lock/save the programs.



RC-12
Wireless Remote Controller

Attached List:

PRG NO.	DIP Switch (1= on, 0 = off)										EFFECT
	10	9	8	7	6	5	4	3	2	1	
00	0	0	0	0	0	0	0	0	0	0	No Light
01	1	0	0	0	0	0	0	0	0	1	White
02	1	0	0	0	0	0	0	0	1	0	Sky-Blue
03	1	0	0	0	0	0	0	0	1	1	Green
04	1	0	0	0	0	0	0	1	0	0	Yellow
05	1	0	0	0	0	0	0	1	0	1	Blue
06	1	0	0	0	0	0	0	1	1	0	Purple
07	1	0	0	0	0	0	0	1	1	1	W, Sky-B, G, Y, B, P Skip (2s)
08	1	0	0	0	0	0	1	0	0	0	W, Sky-B, G, Y, B, P Skip (4s)
09	1	0	0	0	0	0	1	0	0	1	W, Sky-B, G, Y, B, P Skip (6s)
10	1	0	0	0	0	0	1	0	1	0	6 colors fade (0.5RPM)
11	1	0	0	0	0	0	1	0	1	1	6 colors fade (1RPM)
12	1	0	0	0	0	0	1	1	0	0	6 colors fade (1.5RPM)
13	1	0	0	0	0	0	1	1	0	1	6 colors fade (2RPM)
14	1	0	0	0	0	0	1	1	1	0	6 colors fade (3RPM)
15	1	0	0	0	0	0	1	1	1	1	6 colors fade (4RPM)
16	1	0	0	0	0	1	0	0	0	0	6 colors fade (6RPM)