

东莞市欧思科光电科技有限公司

DONGGUAN OPSCO OPTOELECTRONICS CO., LTD

Factory : Lianxing industrial park, xiajie village, Qishi Town, Dongguan City. guangdong province, China

Dongguan Tel: (769)82632725

Dongguan Fax: (769)82632735

SK6812MINIRGBX-XX-P6

3.5x3.7x1.9mm Top SMD Type 0.25Watt Power
targeted light source Intelligent control LED



Change History

Date	Rev. No.	Changes/Reason of changes	Signature
2019-05-15	01	Initial Document	KAEN ZHU

* Before using our products, please search our official website to check the version of specifications. The version of product specifications is updated. We are sorry to fail to inform you in time. Please refer to the latest information on the official website.

* The copyright and final interpretation of the product belong to Dongguan Occidental Optoelectronics Technology Co., Ltd. If you have special specifications, please contact our engineering staff;

东莞市欧思科光电科技有限公司

DONGGUAN OPSCO OPTOELECTRONICS CO., LTD

Factory : Lianxing industrial park, xiajie village, Qishi Town, Dongguan City. guangdong province, China

Dongguan Tel: (769)82632725

Dongguan Fax: (769)82632735

CONTENTS

1、Product overview.....	3
2、Main Application Field.....	3
3、Description.....	3
4、Mechanical Dimensions.....	4
5、PIN configuration.....	4
6、Recommended dimensions for PCB products.....	4
7、General description of product naming.....	5
8、Electrical parameters.....	5
9、Electrical/Optical Characteristics.....	6
10、The IC electrical parameters.....	6
11、Switching characteristics.....	6
12、The data transmission time	7
13、Timing waveform.....	7
14、The method of data transmission.....	7
15、The data structure of 24bit.....	8
16、The typical application circuit.....	8~9
17、Hue Bin Specification for Yellow/Red/Green/Blue.....	9
18、White Color Temperature Ranks.....	10~13
19、Standard LED Performance Graph.....	14
20、Packaging Standard.....	15
21、Reliability Test.....	16
Appendix 1、TOP SMD LED Application Notes.....	17-22

东莞市欧思科光电科技有限公司

DONGGUAN OPSCO OPTOELECTRONICS CO., LTD

Factory : Lianxing industrial park, xiajie village, Qishi Town, Dongguan City. guangdong province, China

Dongguan Tel: (769)82632725

Dongguan Fax: (769)82632735

1. Product Overview :

SK6812MINIRGBX-XX-P6 is a smart LED control circuit and light emitting circuit in one controlled LED source, which has the shape of a 3535 LED chip. Each lighting element is a pixel, and the intensities of the pixels are contained within the intelligent digital interface input. The output is driven by patented PWM technology, which effectively guarantees high consistency of the color of the pixels. The control circuit consists of a signal shaping amplification circuit, a built-in constant current circuit, and a high precision RC oscillator.

The data protocol being used is unipolar RZ communication mode. The 24-bit data is transmitted from the controller to DIN of the first element, and if it is accepted it is extracted pixel to pixel. After an internal data latch, the remaining data is passed through the internal amplification circuit and sent out on the DO port to the remaining pixels. The pixel is reset after the end of DIN. Using automatic shaping forwarding technology makes the number of cascaded pixels without signal transmission only limited by signal transmission speed.

The LED has a low driving voltage (which allows for environmental protection and energy saving), high brightness, scattering angle, good consistency, low power, and long life. The control circuit is integrated in the LED above.

2. Main Application Field:

- Full color LED string light, LED full color module, LED super hard and soft lights, LED guardrail tube, LED appearance / scene lighting
- LED point light, LED pixel screen, LED shaped screen, a variety of electronic products, electrical equipment etc..

3. Description:

- Top SMD internal integrated high quality external control line serial cascade constant current IC;
- control circuit and the RGB chip in SMD 3535 components, to form a complete control of pixel, color mixing uniformity and consistency;
- built-in data shaping circuit, a pixel signal is received after wave shaping and output waveform distortion will not guarantee a line;
- The built-in power on reset and reset circuit, the power does not work;
- gray level adjusting circuit (256 level gray scale adjustable);
- red drive special treatment, color balance;
- line data transmission;
- plastic forward strengthening technology, the transmission distance between two points over 10M;
- Using a typical data transmission frequency of 800 Kbps, when the refresh rate of 30 frames per sec

东莞市欧思科光电科技有限公司

DONGGUAN OPSCO OPTOELECTRONICS CO., LTD

Factory : Lianxing industrial park, xiajie village, Qishi Town, Dongguan City. guangdong province, China

Dongguan Tel: (769)82632725

Dongguan Fax: (769)82632735

4. Mechanical Dimensions:

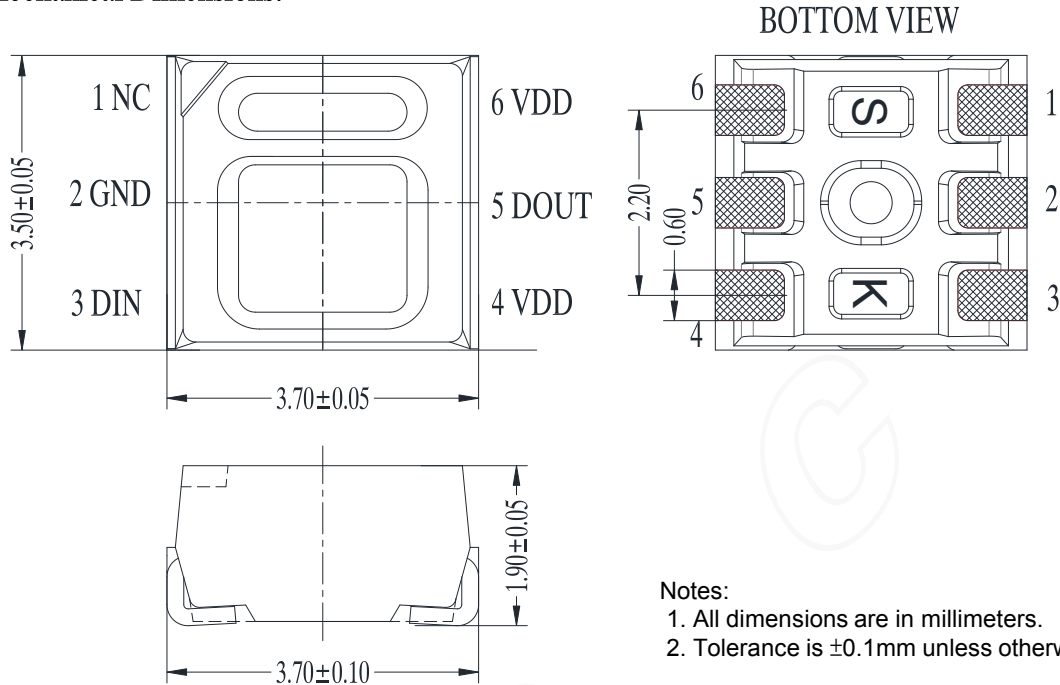

Notes:

1. All dimensions are in millimeters.
2. Tolerance is ± 0.1 mm unless otherwise noted

5. PIN configuration

Item	Symbol	Pin Name	Function description
1	NC	NC	NC
2	GND	Ground	The signal and power supply and grounding
3	DIN	Data Input	control signal input data
4/6	VDD	Power	power supply pin
5	DOUT	Data Output	control signal output data

6. Recommended dimensions for PCB

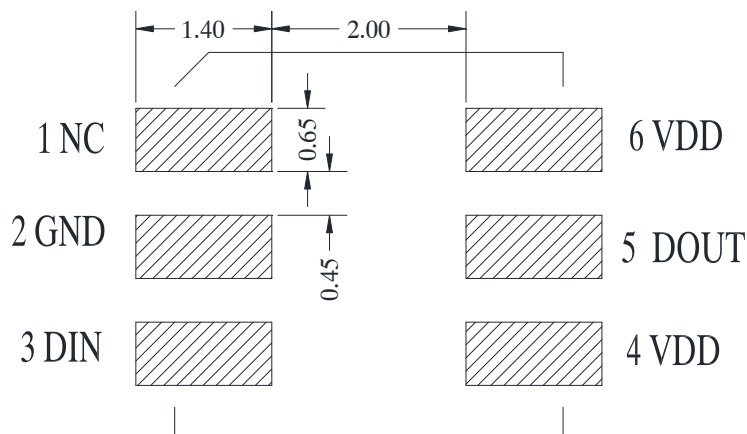

东莞市欧思科光电科技有限公司

DONGGUAN OPSCO OPTOELECTRONICS CO., LTD

Factory : Lianxing industrial park, xiajie village, Qishi Town, Dongguan City. guangdong province, China

Dongguan Tel: (769)82632725

Dongguan Fax: (769)82632735

7. General description of product naming.

SK 6812 MINI-RGBX-XX-P6

① ② ③ ④ ⑤ ⑥

①	②	③	④	⑤	⑥
Series	IC series and current code	Package size	Photochromic Integration Code	White light code	Number of support feet
The default is to integrate the RGB chip with the IC in the 5.4x5.0x1.6mm package outline	Refers to the 68 series IC 6812:12MA current version 6805:5MA current version	MINI: 3.5x3.7x1.9mm contour package	RGBX (W/A): Indicates red, green, blue, white (yellow) four-color package together	XX: BW Blue White 5500-10000K NW Natural White 3800-4500K WS Warm Sunlight 2700-3200K GW GOLD White 2400-2700K	P6: Six Foot Products

8. Electrical Parameter (Ta=25°C, VSS=0V) :

Parameter	Symbol	Range	Unit
Power supply voltage	VDD	+3.7~+5.5	V
Logic input voltage	V _{IN}	-0.5~VDD+0.5	V
Working temperature	Topt	-40~+80	°C
Storage temperature	Tstg	-40~+80	°C
ESD pressure(HBM)	V _{ESD}	4K	V
ESD pressure(DM)	V _{ESD}	200	V

东莞市欧思科光电科技有限公司

DONGGUAN OPSCO OPTOELECTRONICS CO., LTD

Factory : Lianxing industrial park, xiajie village, Qishi Town, Dongguan City. guangdong province, China

Dongguan Tel: (769)82632725

Dongguan Fax: (769)82632735

9. Electrical/Optical Characteristics:

Color	SK6812MINIRGBX-XX-P6		
	Dominate avelength(nm)/ Color temperature (k)	Luminance(mc d)	luminous flux(lm)
Red	620-630	300-500	1.0-2.0
Green	515-530	1000-1500	3.0-4.0
Blue	460-475	200-400	0.5-1.0
Yellew	580-590	300-500	0.5-1.5
WHITE	2400-10000K	1500-2200	4.5-6.5

10. The IC electrical parameters (unless otherwise specified, TA=-20 ~ +70 °C, VDD=4.5 ~ 5.5V, VSS=0V):

Parmeter	Symbol	Min	Typical	Max	Unit	Test conditions
The chip supply voltage	VDD	---	5.2	---	V	---
The signal input flip threshold	VIH	0.7*+ VDD	---	---	V	VDD=5.0V
	VIL	---	---	0.3*+V DD	V	
The frequency of PWM	FPWM	---	1.2	---	KHZ	---
Static power consumption	IDD	---	1	---	mA	---

11. Switching characteristics (Ta=25 °C):

Parameter	Symbol	Min	Typical	Max	Unit	Test conditions
The speed of data transmission	fDIN	---	800	---	KHZ	The duty ratio of 67% (data 1)
DOUT transmission delay	TPLH	---	---	500	ns	DIN→DOUT
	TPHL	---	---	500	ns	
IOUT Rise/Drop Time	Tr	---	100	---	ns	VDS=1.5 Iout R/G/B=9mA Iout W=18mA
	Tf	---	100	---	ns	

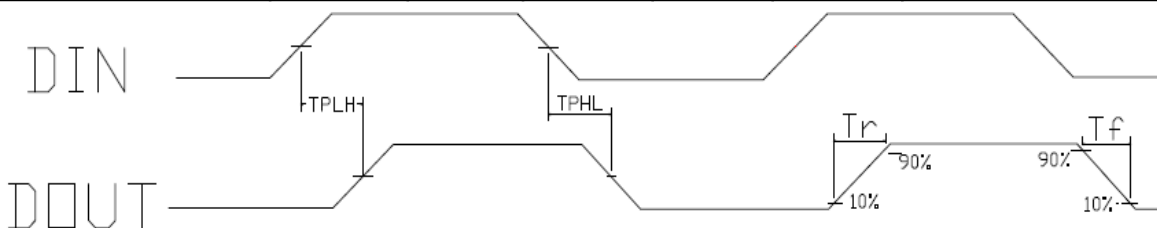

东莞市欧思科光电科技有限公司

DONGGUAN OPSCO OPTOELECTRONICS CO., LTD

Factory : Lianxing industrial park, xiajie village, Qishi Town, Dongguan City. guangdong province, China

Dongguan Tel: (769)82632725

Dongguan Fax: (769)82632735

12. The data transmission time (TH+TL=1.25μs±600ns):

Name		Min.	Standard value	Max.	Unit
T	Code period	1.20	--	--	μs
T0H	0 code, high level time	0.2	0.32	0.4	μs
T0L	0 code, low level time	0.8	--	--	μs
T1H	1 code, high level time	0.58	0.64	1.0	μs
T1L	1 code, low level time	0.2	--	--	μs
Trst	Reset code, low level time	>80	--	--	μs

13. Timing waveform:

Input code:

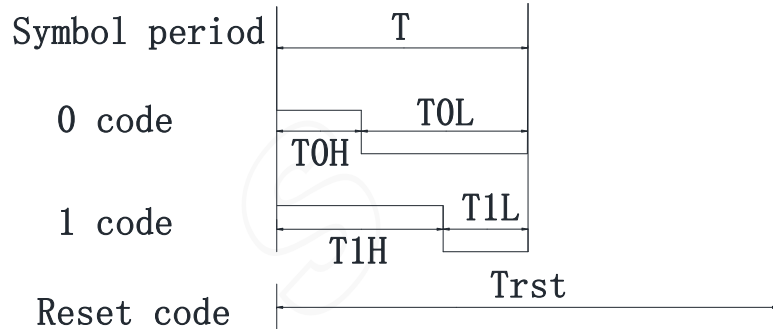

Connection mode:

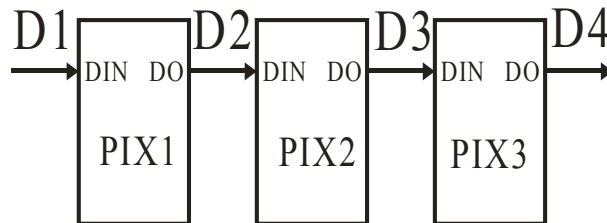

14. The method of data transmission:

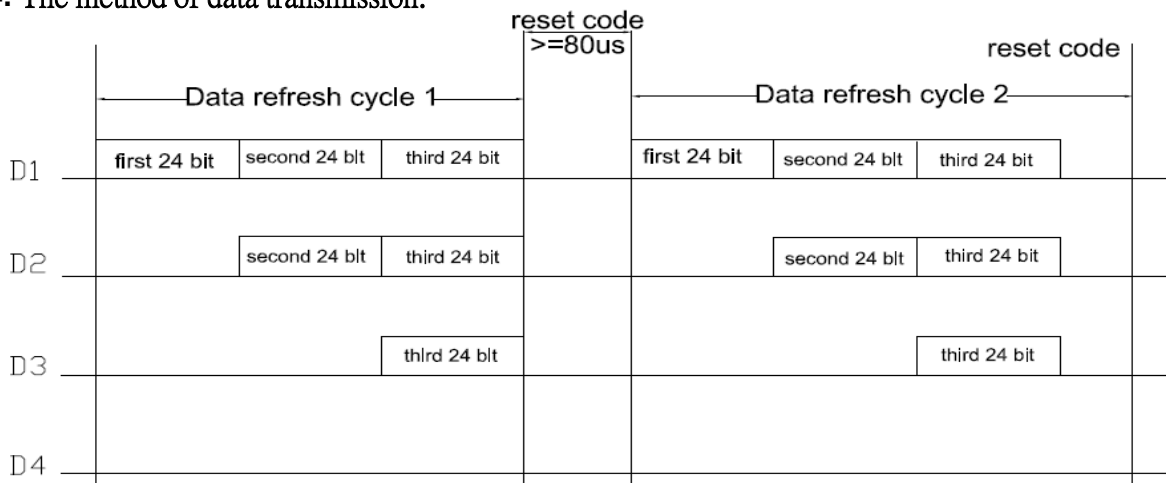

Note: the D1 sends data for MCU, D2, D3, D4 for data forwarding automatic shaping cascade circuit.

东莞市欧思科光电科技有限公司

DONGGUAN OPSCO OPTOELECTRONICS CO., LTD

Factory : Lianxing industrial park, xiajie village, Qishi Town, Dongguan City. guangdong province, China

Dongguan Tel: (769)82632725

Dongguan Fax: (769)82632735

15. The data structure of 24bit:

G7	G6	G5	G4	G3	G2	G1	G0	R7	R6	R5	R4
R3	R2	R1	R0	B7	B6	B5	B4	B3	B2	B1	B0
W7	W6	W5	W4	W3	W2	W1	W0				

Note: high starting, in order to send data (G7 - G6 -B0)

16. The typical application circuit:

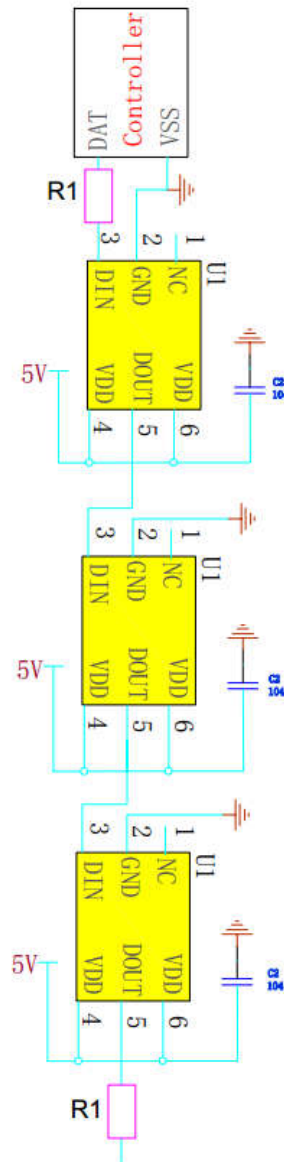

东莞市欧思科光电科技有限公司

DONGGUAN OPSCO OPTOELECTRONICS CO., LTD

Factory : Lianxing industrial park, xiajie village, Qishi Town, Dongguan City. guangdong province, China

Dongguan Tel: (769)82632725

Dongguan Fax: (769)82632735

In the practical application circuit, the signal input and output pins of the IC signal input and output pins should be connected to the signal input and output terminals. In addition, in order to make the IC chip is more stable, even the capacitance between beads is essential back;

Application: used for soft lamp strip or hard light, lamp beads transmission distance is short, suggested in signal in time the clock line input and output end of each connected in series protection resistors, R1 of about 500 ohms.

Application: for module or general special-shaped products, lamp beads transmission distance is long, because of different wire and transmission distance, in the signal in time clock at both ends of the line on grounding protection resistance will be slightly different; to the actual use of fixed;

17. Hue Bin Specification for Yellow 、 Red 、 Green 、 Blue

Name	Code	λ_d MIN (nm)	λ_d MAX (nm)
YELLOW	YL1	585	590
	YL2	590	595
RED	HR1	620	625
	HR2	625	630
BLUE	BL5	460	465
	BL6	465	470
GREEN	PG2	515	520
	PG3	520	525
	PG4	525	530

东莞市欧思科光电科技有限公司

DONGGUAN OPSCO OPTOELECTRONICS CO., LTD

Factory : Lianxing industrial park, xiajie village, Qishi Town, Dongguan City, guangdong province, China

Dongguan Tel: (769)82632725

Dongguan Fax: (769)82632735

18. White Color Temperature Ranks & CIE Color Rank (Refer to CIE 1931 chromaticity diagram)

CIE chromaticity coordinates (ANSI Cool White)

Name	X1	Y1	X2	Y2	X3	Y3	X4	Y4
BW-A	0.2928	0.2822	0.2802	0.2895	0.2885	0.3007	0.3011	0.2934
BW-B	0.3011	0.2934	0.2885	0.3007	0.302	0.3189	0.3147	0.3116
BW-C	0.3147	0.3116	0.302	0.3189	0.3186	0.3412	0.3313	0.3339
BW-D	0.3313	0.3339	0.3186	0.3412	0.3326	0.36	0.3449	0.3522

ANSI Blue White Color bin structures

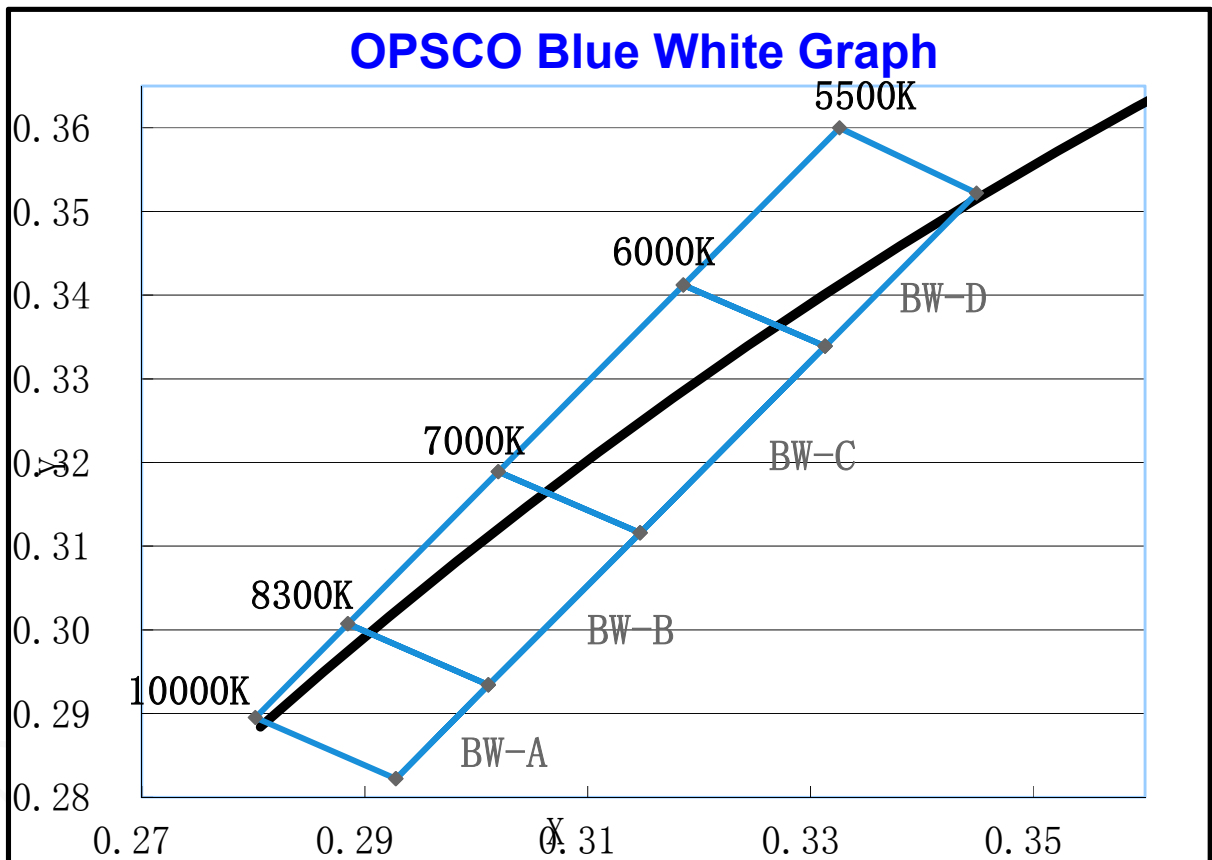

东莞市欧思科光电科技有限公司

DONGGUAN OPSCO OPTOELECTRONICS CO., LTD

Factory : Lianxing industrial park, xiajie village, Qishi Town, Dongguan City. guangdong province, China

Dongguan Tel: (769)82632725

Dongguan Fax: (769)82632735

CIE chromaticity coordinates (ANSI Natural white)

名称	X1	Y1	X2	Y2	X3	Y3	X4	Y4
NO-A	0.358	0.3445	0.3461	0.3521	0.3531	0.36	0.3651	0.3524
NA-A	0.3651	0.3524	0.3531	0.36	0.3602	0.3679	0.3722	0.3603
NB-A	0.3722	0.3603	0.3602	0.3679	0.3659	0.3743	0.3779	0.3667
NC-A	0.3779	0.3667	0.3659	0.3743	0.3716	0.3807	0.3836	0.373
ND-A	0.3836	0.373	0.3716	0.3807	0.3773	0.3871	0.3893	0.3794
NE-A	0.3893	0.3794	0.3773	0.3871	0.3844	0.3949	0.3963	0.3873

ANSI Natural White Color bin structures

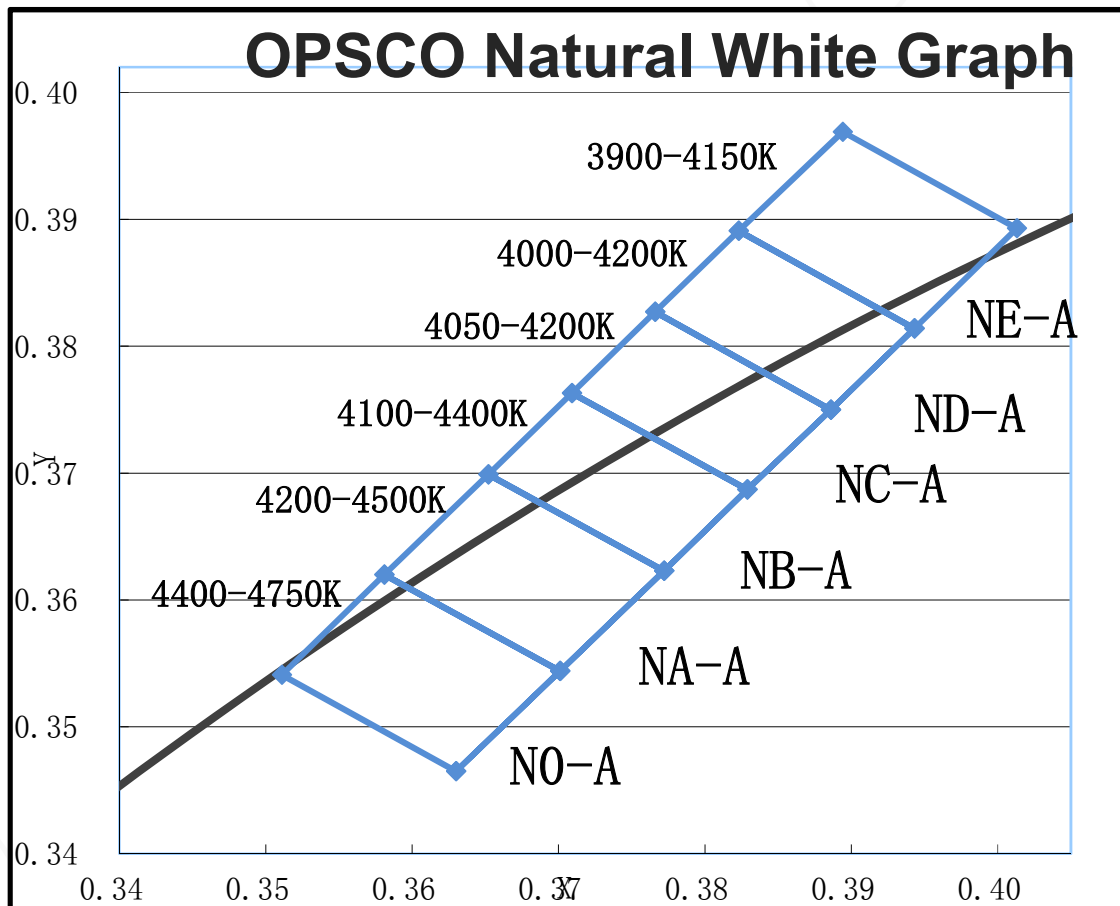

东莞市欧思科光电科技有限公司

DONGGUAN OPSCO OPTOELECTRONICS CO., LTD

Factory : Lianxing industrial park, xiajie village, Qishi Town, Dongguan City. guangdong province, China

Dongguan Tel: (769)82632725

Dongguan Fax: (769)82632735

CIE chromaticity coordinates (ANSI Warm White)

名称	X1	Y1	X2	Y2	X3	Y3	X4	Y4
K1-A	0.4344	0.4032	0.4221	0.3984	0.4147	0.3814	0.426	0.3853
K2-A	0.443	0.4212	0.4299	0.4165	0.4221	0.3984	0.4344	0.4032
K3-A	0.4562	0.426	0.443	0.4212	0.4344	0.4032	0.4465	0.4071
K4-A	0.4465	0.4071	0.4344	0.4032	0.426	0.3853	0.4373	0.3893
L1-A	0.4586	0.4103	0.4465	0.4071	0.4373	0.3893	0.4483	0.3918
L2-A	0.4687	0.4289	0.4562	0.426	0.4465	0.4071	0.4586	0.4103

ANSI Warm White Color bin structures

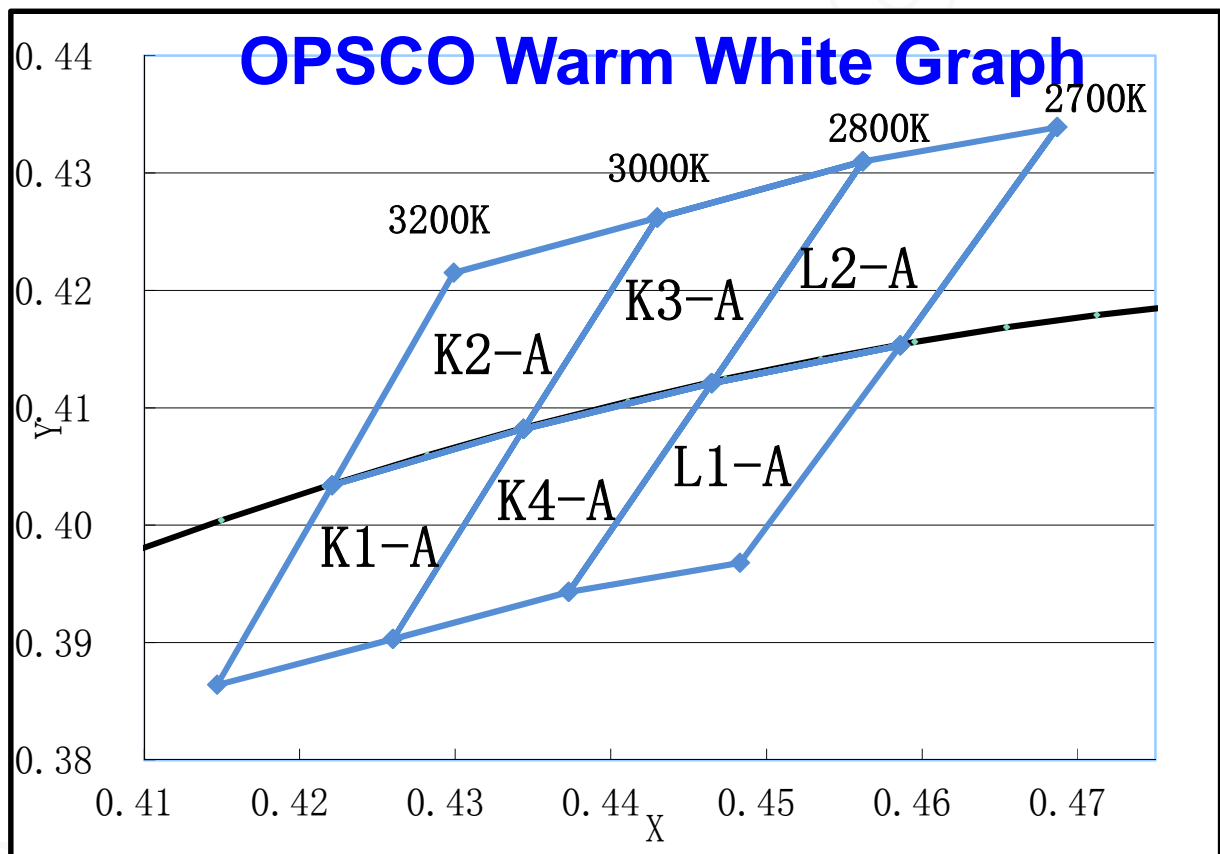

东莞市欧思科光电科技有限公司

DONGGUAN OPSCO OPTOELECTRONICS CO., LTD

Factory : Lianxing industrial park, xiajie village, Qishi Town, Dongguan City. guangdong province, China

Dongguan Tel: (769)82632725

Dongguan Fax: (769)82632735

CIE chromaticity coordinates (ANSI Warm Lighting)

CA	X1	Y1	X2	Y2	X3	Y3	X4	Y4
GA	0.459741	0.3982	0.4548	0.4045	0.4613	0.4096	0.4662	0.4033
GB	0.466212	0.4033	0.4613	0.4096	0.4677	0.4147	0.4727	0.4084
GC	0.472682	0.4084	0.4677	0.4147	0.4742	0.4198	0.4792	0.4135
GD	0.479152	0.4135	0.4742	0.4198	0.4807	0.4248	0.4856	0.4185
GE	0.485622	0.4185	0.4807	0.4248	0.4872	0.4299	0.4921	0.4236
GA1	0.462676	0.3945	0.4597	0.3982	0.4662	0.4033	0.4693	0.3994
GB1	0.469255	0.3994	0.4662	0.4033	0.4727	0.4084	0.4758	0.4044
GC1	0.475835	0.4044	0.4727	0.4084	0.4792	0.4135	0.4824	0.4093
GD1	0.482415	0.4093	0.4792	0.4135	0.4856	0.4185	0.489	0.4142
GE1	0.488995	0.4142	0.4856	0.4185	0.4921	0.4236	0.4956	0.4192

ANSI Warm Lighting Color bin structures

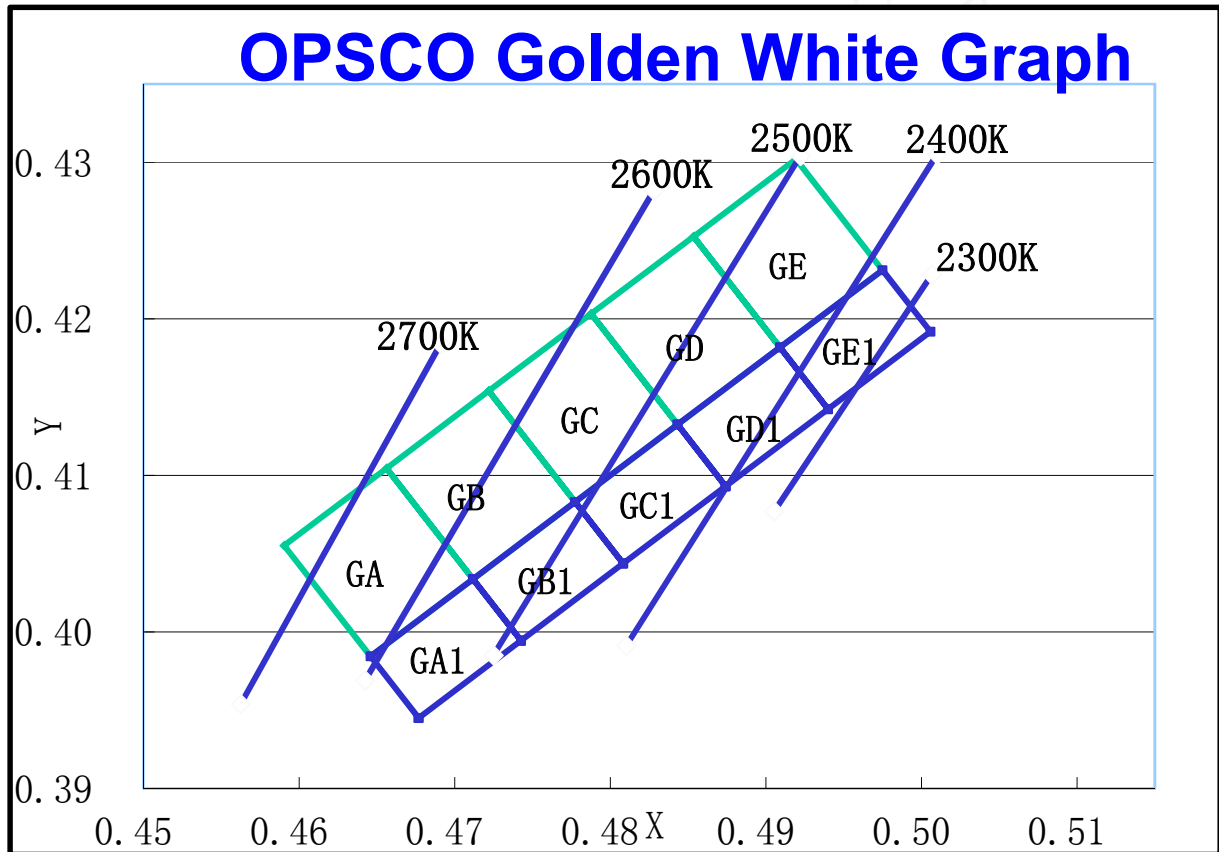

- Color coordinates measurement allowance is ± 0.005
- To order specify color temperature ranks, please contact OPSCO Lighting Holdings LTD. for further information.
- Thermal Pad Temperature @25°C @ 20mA

东莞市欧思科光电科技有限公司

DONGGUAN OPSCO OPTOELECTRONICS CO., LTD

Factory : Lianxing industrial park, xiajie village, Qishi Town, Dongguan City. guangdong province, China

Dongguan Tel: (769)82632725

Dongguan Fax: (769)82632735

19. Standard LED Performance Graph:

Thermal Pad Temperature vs. Relative Light Output

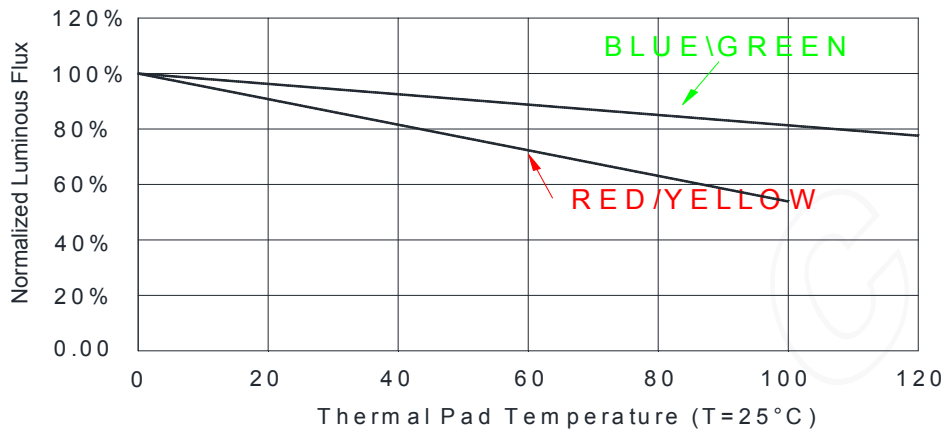

Wavelength Characteristics

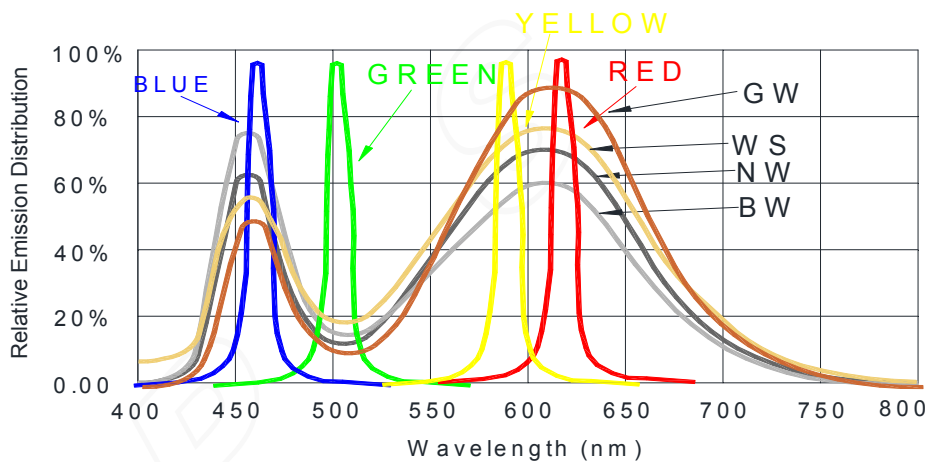

Typical Radiation Pattern 120°

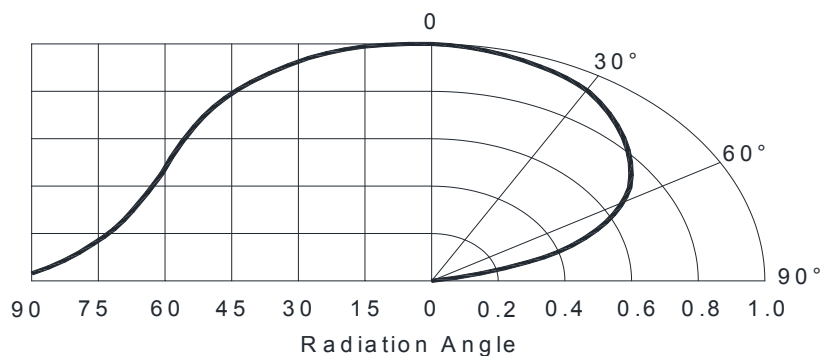

东莞市欧思科光电科技有限公司

DONGGUAN OPSCO OPTOELECTRONICS CO., LTD

Factory : Lianxing industrial park, xiajie village, Qishi Town, Dongguan City. guangdong province, China

Dongguan Tel: (769)82632725

Dongguan Fax: (769)82632735

20. Packaging Standard:

SK6812MINIRGBX-XX-P6

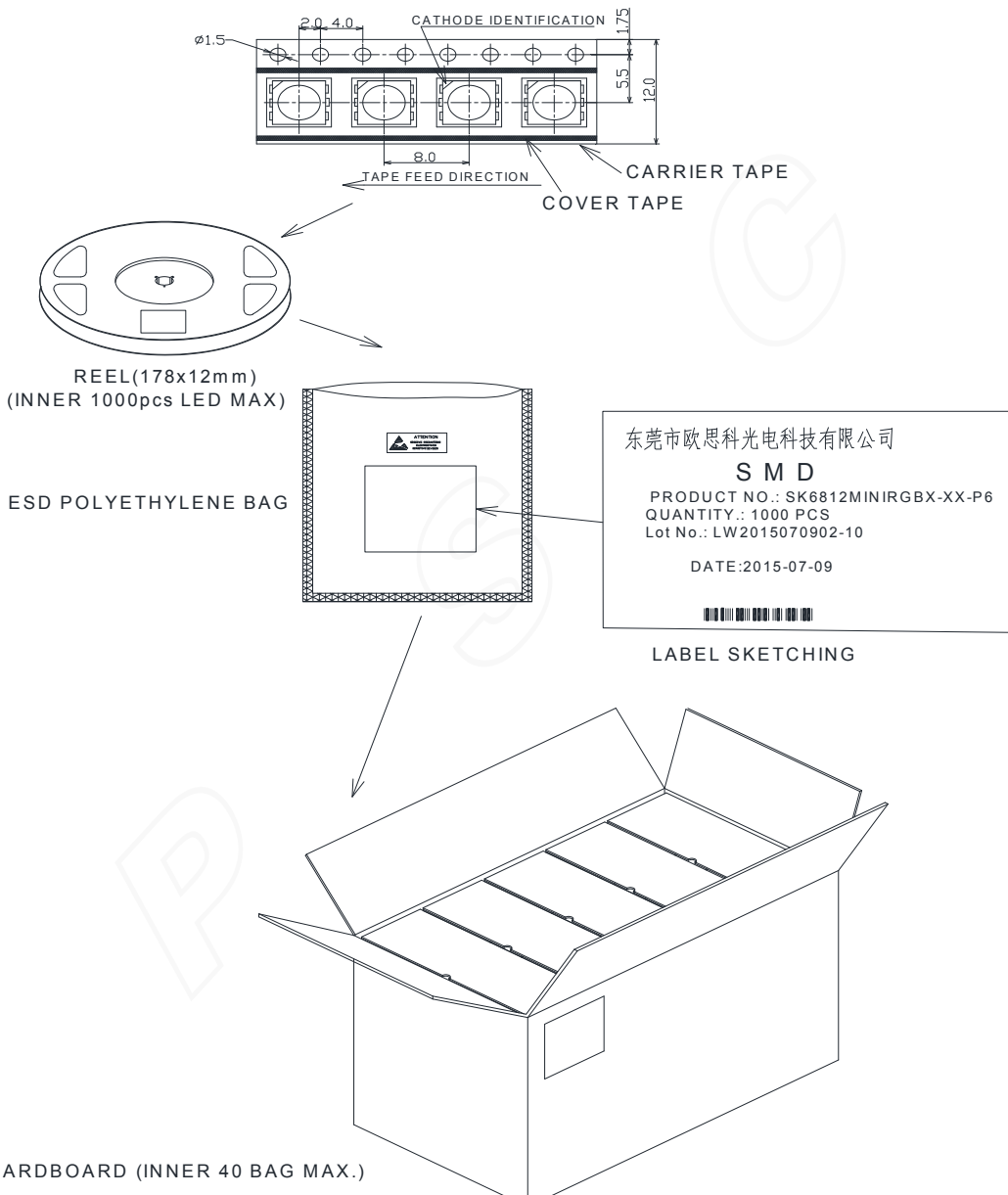

The reel pack is applied in SMD LED. The LEDs are packed in cardboard boxes after packaging in normal or anti-electrostatic bags. cardboard boxes will be used to protect the LEDs from mechanical shocks during transportation. The boxes are not water resistant and therefore must be kept away from water and moisture.

东莞市欧思科光电科技有限公司

DONGGUAN OPSCO OPTOELECTRONICS CO., LTD

Factory : Lianxing industrial park, xiajie village, Qishi Town, Dongguan City. guangdong province, China

Dongguan Tel: (769)82632725

Dongguan Fax: (769)82632735

21. Reliability Test :

NO.	Test item	Test Conditions	Reference	Criterion
1	Thermal Shock	100 ± 5° C ~ -40° C ± 5° C 30min~30min 300 cycles	MIL-STD-202G	0/22
2	High Temperature Storage	Ta= +100° C 1000hrs	JEITA ED-4701 200 201	0/22
3	Low Temperature Storage	Ta= -40° C 1000hrs	JEITA ED-4701 200 202	0/22
4	High Temperature High Humidity Storage	Ta=60° C RH=90% 1000hrs	JEITA ED-4701 100 103	0/22
5	Temperature Cycle	-55° C~25° C~100° C~25° C 30min~5min~30min~5min 100 cycles	JEITA ED-4701 100 105	0/22
6	Resistance to Soldering Heat	Tsld = 260° C, 10sec. 3 times	JEITA ED-4701 300 301	0/22
7	Room temp Life Test	25° C, IF: Typical current , 1000hrs	JESD22-A 108D	0/22

Criteria for Judging the Damage:

Item	Symbol	Test Condition	Limit	
			Min	Max
Luminous Intensity	IV	DC=5V, Typical current	Init. Value*0.7	---
Resistance to Soldering Heat	---	DC=5V, Typical current	No dead lights or obvious damage	

东莞市欧思科光电科技有限公司

DONGGUAN OPSCO OPTOELECTRONICS CO., LTD

Factory : Lianxing industrial park, xiajie village, Qishi Town, Dongguan City. guangdong province, China

Dongguan Tel: (769)82632725

Dongguan Fax: (769)82632735

APEENDIX 1.TOP SMD LED Application Notes

1. Features

The Purposes of making OPSCO's customers and users to have a clear understanding on the ways how to use the LED.

2. Description

Generally. The LED can be used the same way as other general purposed semiconductors. When using OPSCO's TOP SMD LED, the following precautions must be taken to protect the LED.

3. Cautions

3.1. Dust & Cleaning

This emitter has a silicone surface, There are many benefits to the silicone surface in terms of optical properties and improved reliability. However, silicone is a softer material and prone to attract dust. While a minimal amount of dust and debris on the LED will not cause significant reduction in illumination, steps should be taken to keep the emitter free of dust.

These include keeping the LEDs in the manufacturer's package prior to assembly and storing assemblies in an enclosed area after installing the emitters.

Surface condition of this device may change when organic solvents such as trichloroethylene or acetone were applied.

Avoid using organic solvent, it is recommended that isopropyl be used as a solvent for cleaning the LEDs. When using other solvents, it should be confirmed beforehand whether the solvents will dissolve the package and the resin of not.

Do not clean the LEDs by the ultrasonic. When it is absolutely necessary, the influence as ultrasonic cleaning on the LEDs depends on factors such as ultrasonic power. Baking time and assembled condition. Before cleaning, a pre-test should be done to confirm whether any damage to the LEDs will occur.

3.2. Shipment and storage

TOP SMD LED is a humidity sensor, the LED packaging in the aluminum bag is to avoid the LED in the transport and storage of moisture absorption, in the bag with a desiccant to absorb the moisture inside the bag. If the LED absorbs water vapor, then in the LED over reflow, in the high temperature state, into which the rapid expansion of gas vaporization and produce a greater internal stress, so that the material crack, layered or damaged bonding wire , Resulting in product failure.

TOP SMD LED with a moisture-proof anti-static aluminum foil bag packaging, handling should avoid the process of squeezing, piercing the case of bags, and do the necessary anti-static protective measures; promise products on the line before the leak or broken, Please stop the use of direct use of the product; , Resulting in product failure;

Such as before the material has been found to prevent moisture-proof aluminum foil bags have been opened, damaged, perforated can be returned to the original re-dehumidification, must not be on-line use;

The humidity level of this product is LEVEL5a.

东莞市欧思科光电科技有限公司

DONGGUAN OPSCO OPTOELECTRONICS CO., LTD

Factory : Lianxing industrial park, xiajie village, Qishi Town, Dongguan City. guangdong province, China

Dongguan Tel: (769)82632725

Dongguan Fax: (769)82632735

Chart 1: Definition of material's MSL prescribed by IPC/JEDECJ-STD-020E

Moisture proof	Workshop lifespan after open the packaging	
	Time	condition
LEVEL1	unlimited	≤30°C/85 % RH
LEVEL2	1 year	≤30°C/60 % RH
LEVEL2a	4 Weeks	≤30°C/60 % RH
LEVEL3	168 Hours	≤30°C/60 % RH
LEVEL4	72 Hours	≤30°C/60 % RH
LEVEL5	48 Hours	≤30°C/60 % RH
LEVEL5a	24 Hours	≤30°C/60 % RH
LEVEL6	Take off and use immediately	≤30°C/60 % RH

3.3. Storage before unsealing

In order to avoid the reliability failure caused by moisture absorption and dampness, it is necessary to do a good job of pre-SMT storage and moisture-proof measures for LED products.

3.3.1 If the moistureproof bag is not opened, the storage time of TOP SMD components is less than 2 months under 30 C/60% RH; (Note: the date of the label is taken as the standard, and the packaging is used without air leakage and moisture indicator card moisture-proof beads are not discolored; for different moisture-proof grade materials or packaging, there are certain differences in the storage time, the specific storage time is based on specifications or packaging bag tips; It is suggested that the moisture-proof bag should not be opened at will before assembly.)

3.3.2 The lamp beads exceeded the effective storage time, but did not exceed the packaging date for 6 months. Before use, the lamp beads need to be re-dehumidified. Bag removal and baking at 70 C/48H or above can be used. After dehumidification, the oven can not be powered off. Take one roll and stick one roll in the process of using. The unused ones are kept in the oven at 70 C. Not all the materials can be taken out and put in the workshop. Absolutely not to dehumidify during the day, power off the oven at night, and then patch the next day (the maximum dehumidification time should not be greater than 96H, specific dehumidification baking parameters refer to 3.6.2 items.)

3.3.3 The beads exceed the packing date for 6 months. Please return them to OSCO for processing.

3.3.4 Moisture-proof packaging bags are leaky, perforated or damaged. They can not be used after baking. Please return them to OSCO for treatment.

3.4. Control after the packing bag is opened

After opening the moisture-proof bag, please read the moisture-proof bag inside the humidity indicator card in the moisture-proof beads into pink to confirm moisture in the moisture bag is too much, according to the color of the ball to determine whether the bag material on-line operation; And the material after opening the package should be strictly controlled in the table 1 as specified by the maximum temperature and humidity and operating time allowed, as long as the material exposed in the environment described in Table 1, the need to accumulate its use in the workshop time. Open the bag and paste the material on the PCB board, should be completed within 0.5H welding work, do not recommend the material attached to the PCB, a long time stay in the workshop does not carry out SMT work; Caused by adverse water within the lead;

3.5. Definition of humidity card

Open the package after the TOP SMD LED bag inside the humidity card color instructions are as follows:

- If the moisture card 10% of the moisture-proof beads into pink, other files for the blue, this situation, LED can be used directly;
- If the humidity card moisture-proof beads 10%, 20% at all become pink, in fact, the file is blue, this situation, the need for low-temperature components dehumidification;
- If the humidity card moisture-proof beads 10%, 20%, 30% more than three are turned pink, in this case, the customer needs to return the material to our company for high humidity dehumidification, re-packaging before use;

东莞市欧思科光电科技有限公司

DONGGUAN OPSCO OPTOELECTRONICS CO., LTD

Factory : Lianxing industrial park, xiajie village, Qishi Town, Dongguan City. guangdong province, China

Dongguan Tel: (769)82632725

Dongguan Fax: (769)82632735

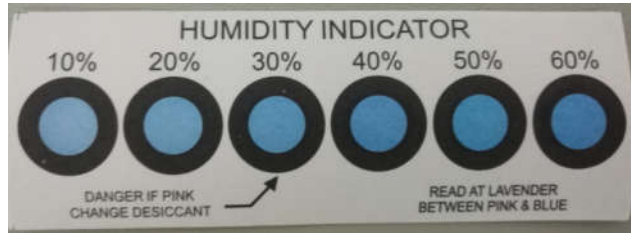

Humidity indicator D0 not change color

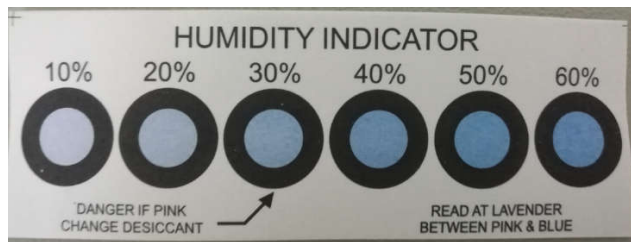

Humidity indicator turns pink in 10% 20%

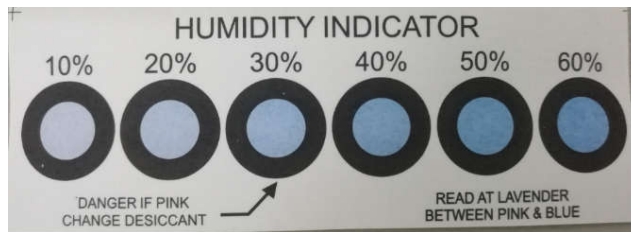

Humidity indicator turns pink in 10% 20% 30%

3.6. Unwanted material moisture-proof storage and moisture-proof control of finished material

If a roll of SMDs is not used at once and the plant temperature and humidity are within the defined conditions ($<30^{\circ}\text{C}$ / $60\% \text{RH}$), the exposure time of the element in the air does not exceed 2H, the remaining material should be carried out together with the desiccant Vacuum sealed, otherwise, the material must be low-wet baking dehumidification; dehumidified material can be re-packaged to re-start the calculation time;

Perform moisture control on SMDs components that have been assembled

- After the components have been assembled to the PCB board no longer need to go through the high temperature process or reflow process, it will not be special treatment;
- Do not need to do the necessary dehumidification work before making the appropriate protection process, bake in $70^{\circ}\text{C} \pm 5^{\circ}\text{C}$ oven baking for less than 48 hours, To remove the product in the detection and aging process exposed to moisture in the air to avoid the product in the protective treatment, the package in the material surface of the moisture will slowly invade the product, will cause product failure (Specific desiccant baking parameters refer to 3.6.2 items);
- For products that require secondary SMT process or high temperature, they should be subjected to the necessary moisture treatment before secondary welding, after exposure to ($<30^{\circ}\text{C}$ / $60\% \text{RH}$), The maximum length of not more than 4H, Connaught second high temperature process separated by a long time, then a welding material must be necessary dehumidification work ($70^{\circ}\text{C} \pm 5^{\circ}\text{C}$ oven baking no less than 48 hours), and then pumping Vacuum storage; or the first product stored in the oven or with a desiccant container, the second high-temperature process before doing dehumidification work ($70^{\circ}\text{C} \pm 5^{\circ}\text{C}$ in the oven baking no less than 48 hours), To ensure that products in the high temperature before the process is not damp (Specific desiccant baking parameters refer to 3.6.2 items);

Low-temperature baking conditions: $70^{\circ}\text{C} \pm 5^{\circ}\text{C}$ baking not less than 48 hours high temperature baking conditions: $130^{\circ}\text{C} \pm 5^{\circ}\text{C}$ baking not less than 6 hours (lamp beads must be split into particles)

东莞市欧思科光电科技有限公司

DONGGUAN OPSCO OPTOELECTRONICS CO., LTD

Factory : Lianxing industrial park, xiajie village, Qishi Town, Dongguan City. guangdong province, China

Dongguan Tel: (769)82632725

Dongguan Fax: (769)82632735

3.6.2 The relationship between ambient humidity and dehumidification time for low temperature/high temperature dehumidification:

Ambient humidity	Oven temperature	baking time	Baking method
40%	70C°	24H	Remove from the static bag and bake with the reel to dehumidify.
50%	70C°	48H	
>60%	70C°	Ineffective dehumidification baking	
40%	130C°	6H	Lamp beads must be dismantled into granules to bake and dehumidify
50%	130C°	12H	

3.7. Reflow Soldering Characteristics

In testing, OPSCO has found SMD LEDs to be compatible with JEDEC J-STD-020E, using the parameters listed below. As a general guideline OPSCO recommends that users follow the recommended soldering profile provided by the manufacturer of solder paste used.

Note that this general guideline is offered as a starting point and may require adjustment for certain PCB designs and Configurations of reflow soldering equipment.

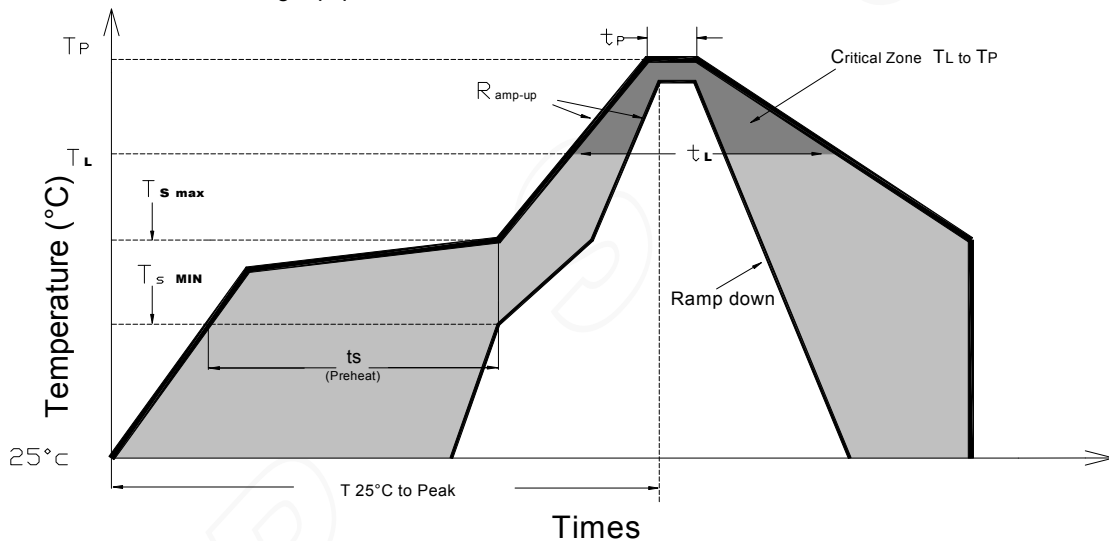

Profile Feature	Lead-Based Solder	Lead-Free Solder
Average Ramp-Up Rate (Ts _{max} to Tp)	3°C/second max.	3°C/second max.
Preheat: Temperature Min (Ts _{min})	100°C	150°C
Preheat: Temperature Min (Ts _{max})	150°C	200°C
Preheat: Time (ts _{min} to ts _{max})	60-120 seconds	60-180 seconds
Time Maintained Above: Temperature (T _l)	183 °C	217 °C
Time Maintained Above: Time (t _l)	60-150 seconds	60-150 seconds
Peak/Classification Temperature (T _p)	215 °C	240 °C
Time Within 5°C of Actual Peak Temperature (tp)	<10 seconds	<10 seconds
Ramp-Down Rate	6°C/second max.	6°C/second max.
Time 25 °C to Peak Temperature	<6 minutes max.	<6 minutes max.

Note: All temperatures refer to topside of the package, measured on the package body surface.

东莞市欧思科光电科技有限公司

DONGGUAN OPSCO OPTOELECTRONICS CO., LTD

Factory : Lianxing industrial park, xiajie village, Qishi Town, Dongguan City. guangdong province, China

Dongguan Tel: (769)82632725

Dongguan Fax: (769)82632735

3.8 General design requirements :

. SMT nozzle requirements: (red circle refers to the nozzle diameter)

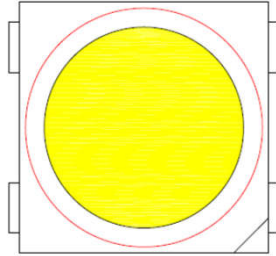

OK (nozzle diameter is greater than the light bulb area)

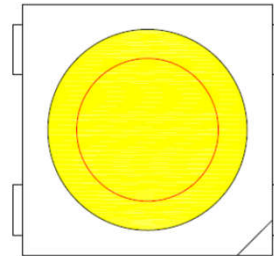

NG (nozzle diameter is less than the light beads light area)

- . Material to take way: with tweezers folder material, can not press the colloid or sharp objects to touch the colloid, the material can not be stacked;

a. Correct handling

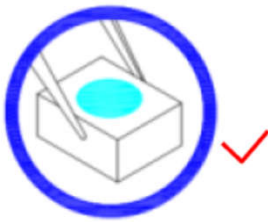

b. Wrong handling and wrong display after assembling

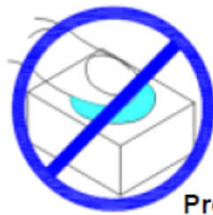

Pressing gels

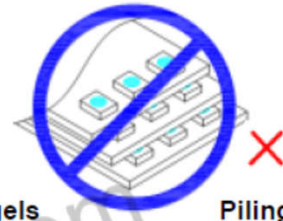

Piling up material

- . Products in the PCB layout design, for the soft sheet, and 0.5T below the plate, the pad direction should be perpendicular to the direction of PCB extension to reduce the PCB board bending stress generated in the LED pin, resulting in LED products Due to stress acting tensile failure;

3.9 Heat Generation:

Thermal design of the end product is of paramount importance. Please consider the heat generation of the LED when making the system design. The coefficient of temperature increase per input electric power is affected by the thermal resistance of the circuit board and density of LED placement on the board, as well as components. It is necessary to avoid in tense heat generation and operate within the maximum rating given in this specification. The operating current should be decided after considering the ambient maximum temperature of LEDs

The maximum working temperature of the product is not easy to exceed 60 ° C (≤ 60 ° C, refers to the product pin at the operating temperature)

东莞市欧思科光电科技有限公司

DONGGUAN OPSCO OPTOELECTRONICS CO., LTD

Factory : Lianxing industrial park, xiajie village, Qishi Town, Dongguan City. guangdong province, China

Dongguan Tel: (769)82632725

Dongguan Fax: (769)82632735

4.0 Electrostatic Discharge & Surge Current :

Electrostatic discharge (ESD) or surge current (EOS) may damage LED.

Precautions such as ESD wrist strap, ESD shoe strap or antistatic gloves must be worn whenever handling of LED.

IC device signal input and output ports must be connected in series protection resistor to prevent surge or static shock port caused by product failure;

All devices, equipment and machinery must be properly grounded.

It is recommended to perform electrical test to screen out ESD failures at final inspection.

It is important to eliminate the possibility of surge current during circuitry design.

4.1 Moisture Proof Package

Cannot take any responsibility for any trouble that are caused by using the LEDs at conditions exceeding our specifications.

The LED light output is strong enough to injure human eyes. Precautions must be taken to prevent looking directly at the LEDs with unaided eyes for more than a few seconds.

The formal specification must be exchanged and signed by both parties before large volume purchase begins.

The appearance and specifications of the product may be modified for improvement without notice.